

Neoteric Hovertrek Deluxe with reverse system

Instrumentation Panel and Control Details for 4 Passenger

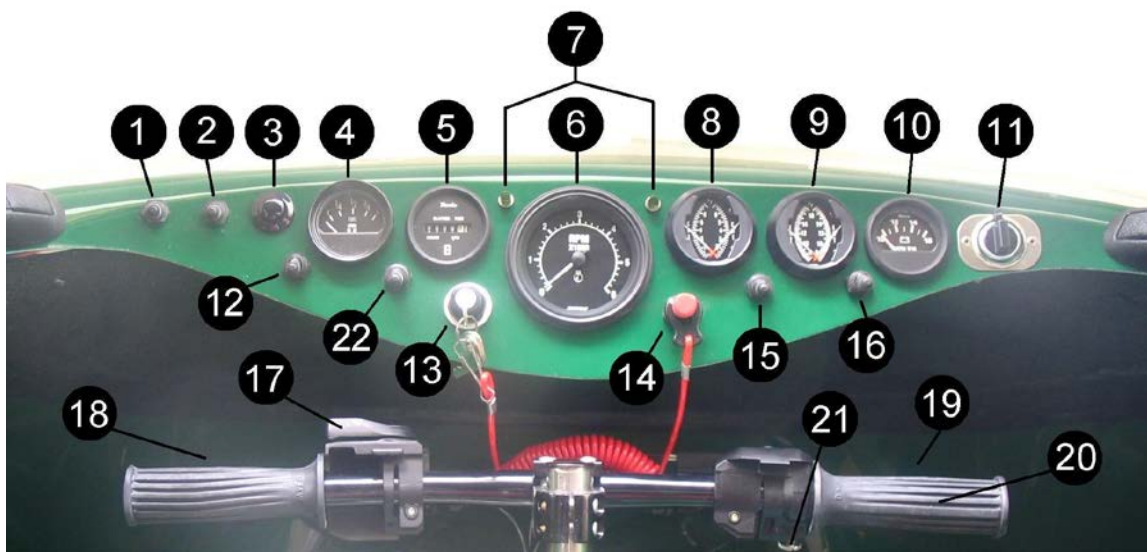

(Part #'s)

1. Headlight Switch (1652)
2. Navigation & Instrument Light Switch (1652)
3. Horn Button (2443)
4. Gasoline/Petrol Gauge (1628)
5. Hour Meter (6148)
6. Tachometer (5351)
7. Reverse Thrust Diagnostic Lights (5633)
8. Engine 2 Cylinder Head Temperature (5326)
9. Engine 2 Exhaust Gas Temperature (5327)
10. Volt Meter (5817)
11. 12 Volt Supply Cigarette Plug (5688)
12. Bilge Pump (1652)
13. Ignition Switch (1884)
14. Kill Switch (1052)
15. Reverse Thrust On Off Switch (1652)
16. Reverse Thrust Reset Switch (2431)
17. Choke Lever (7348)
18. Port Reverse Thrust Control Lever (7369)
19. Starboard Reverse Thrust Control Lever (7369)
20. Throttle Grip (6617)
21. Throttle Cruise Control Lock Screw or Lever (7444)
22. Electric Fuel Pump (1652)



(Part #'s)

1. Emergency Light Switch (1652)
2. Headlight Switch (1652)
3. Navigation & Instrument Light Switch (1652)
4. Horn Button (2443)
5. Bilge Pump Switch (1652)
6. Gasoline/Petrol Gauge (1628)
7. Volt Meter (5817)
8. Ignition Switch (1884)
9. Reverse Thrust Diagnostic Lights (5633)
10. Tachometer W/ hour meter (5351)
11. Kill Switch (1052)
12. Engine 2 Cylinder Head Temperature (5326) (CHT)
13. Reverse Thrust On Off Switch (1652)
14. Engine 2 Exhaust Gas Temperature (5327) (EGT)
15. Reverse Thrust Reset Switch (2431)
16. 12 Volt Supply Cigarette Plug (5688)
17. Electric Fuel Pump Switch (1652) (Fuel Injection Only) Plastic Plug (2449)

Neoteric Hovertek Deluxe with reverse system

Instrumentation Panel and Control Details for 6 Passenger

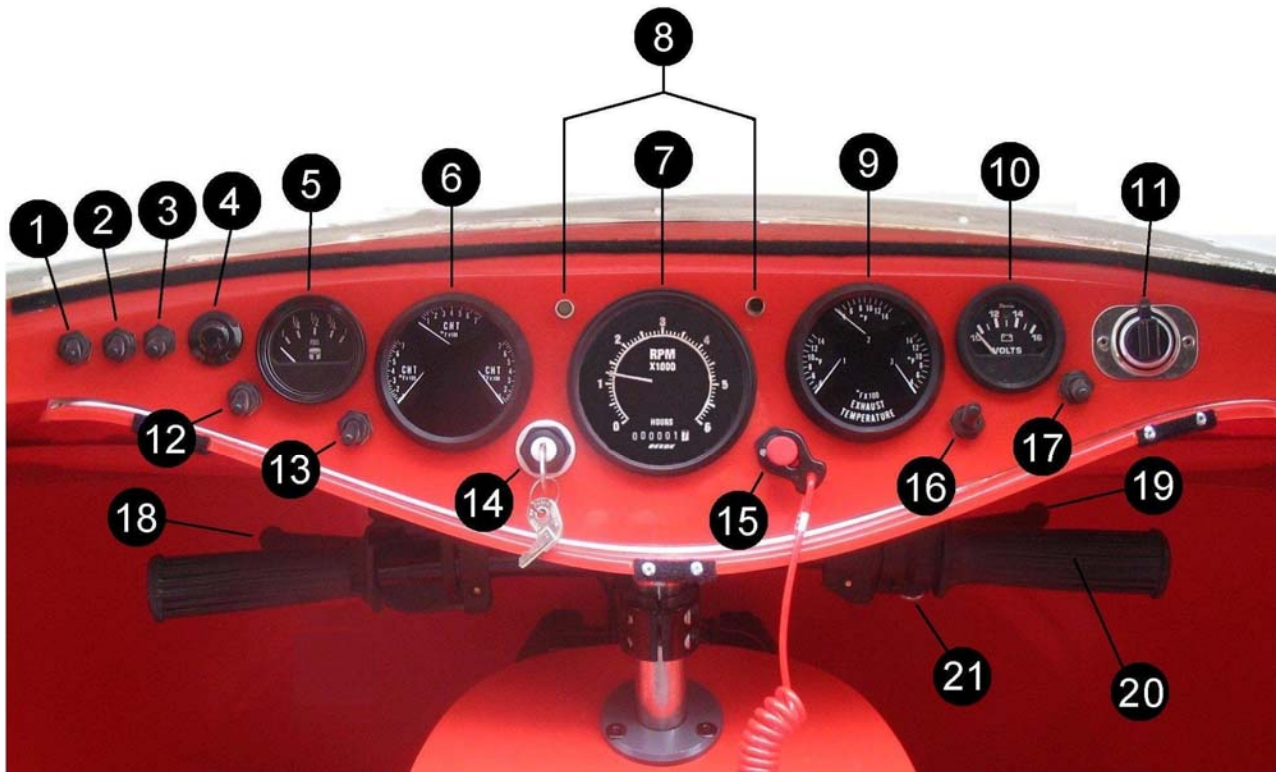

1. Strobe Emergency Light (1652)
2. Headlights (1652)
3. Navigation & Instrument Light Switch (1652)
4. Horn/Siren Button (2443)
5. Gasoline/Petrol Gauge (1628)
6. Engine Cylinder Head Temperature or Water Temperature, depending on gauge type (water temp gage 6166)
7. Tachometer and hour meter (5350)
8. Reverse Thrust Diagnostic Lights (5633)
9. Engine Exhaust Gas Temperature (5647)
10. Volt Meter (5817)
11. 12 Volt Supply Cigarette Plug (5688)
12. Bilge Pump (1652)
13. Electric Fuel Pump (1652)
14. Ignition Switch (1884)
15. Kill Switch (1052)
16. Reverse Thrust On Off Switch (1652)
17. Reverse Thrust Reset Switch for Calibration (2431)
18. Port Reverse Thrust Control Lever (7369)
19. Starboard Reverse Thrust Control Lever (7369)
20. Throttle Grip (6617)
21. Throttle Cruise Control Lock Screw or Lever (7444)

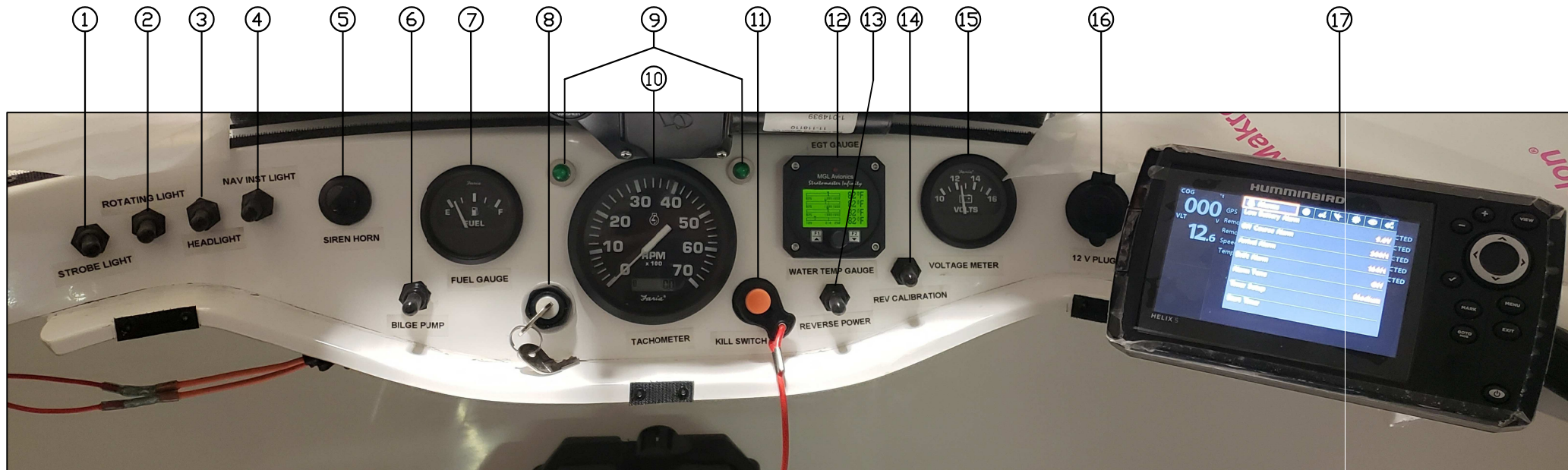

- 1) Strobe Light Switch (1652)
- 2) Rotating Light Switch (1652)
- 3) Headlight Switch (1652)
- 4) Nav Light Switch (1652)
- 5) Horn Button (2443)
- 6) Bilge Pump Switch (1652)
- 7) Fuel Gauge (1628)
- 8) Ignition Switch (1884)
- 9) LED Reverse Diagnostic Lights (5633)
- 10) Tachometer W/ Hour Meter (5351)
- 11) Kill Switch (1052)
- 12) EGT and Water Temp Gauge (9285)
- 13) Reverse Power Switch (1652)
- 14) Reverse Reset, Momentary Switch (2431)
- 15) Volt Meter Gauge (5817)
- 16) 12V Power Supply (5688)
- 17) GPS Options Helix 5 (9482) Garmin (9065)

NOTES:

- 1) EGT COMPRESSION FITTING COMES WITH EGT PROBE WHEN PURCHASED.
- 2) CAN ORDER JUST COMPRESSION FITTING IF NEEDED.
- 3) NEW COOLANT TEMP. COMPRESSION FITTING COMES WITH PROBE WHEN PURCHASED.
- 4) NEW COOLANT TEMP PROBES NUMBER 6, 7 AND 8 CHANGED TO 20 FEB, 2018.

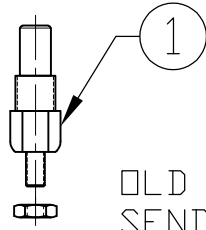

OLD WATER TEMP SENDER

BILL OF MATERIAL		
REF.	PART #	DESCRIPTION
1	6277	WATER TEMP SENDER
2	7479	FUEL SENDER
3	7719	EGT TEMPERATURE PROBE
4	7928	CHT TEMPERATURE SENSOR
5	7945	EGT COMPRESSION FITTING
6	9434	COOLANT TEMP PROBE
7	9435	COOLANT TEMP COMP. FITTING
8	9446	COPPER SEALING WASHER

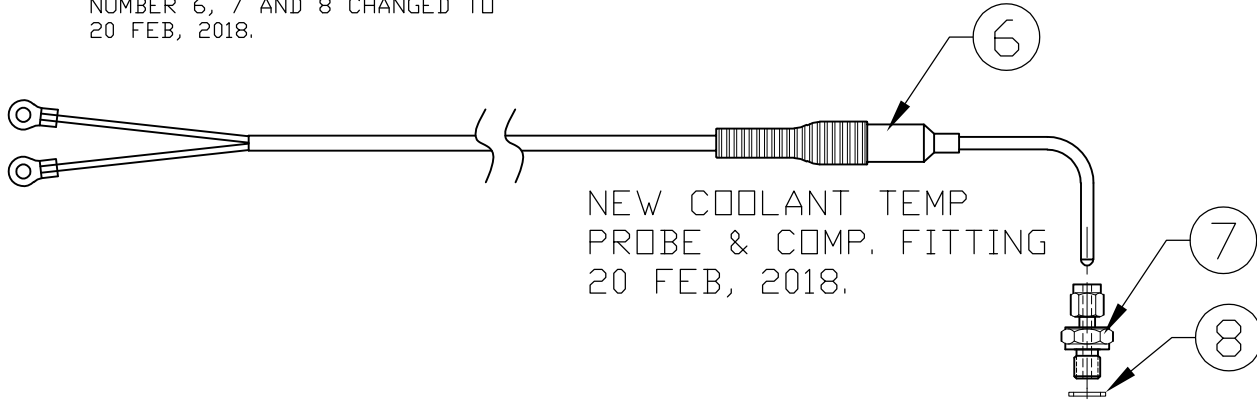

NEW COOLANT TEMP PROBE & COMP. FITTING
20 FEB, 2018.

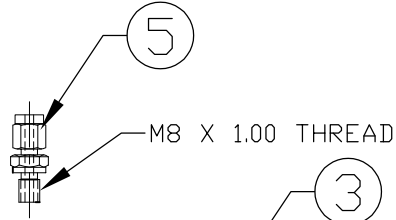

M8 X 1.00 THREAD

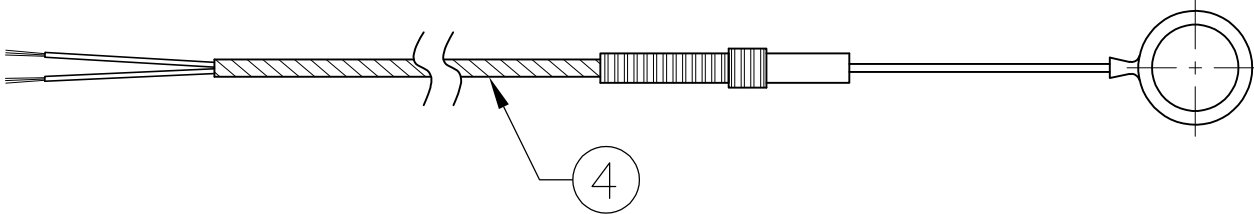
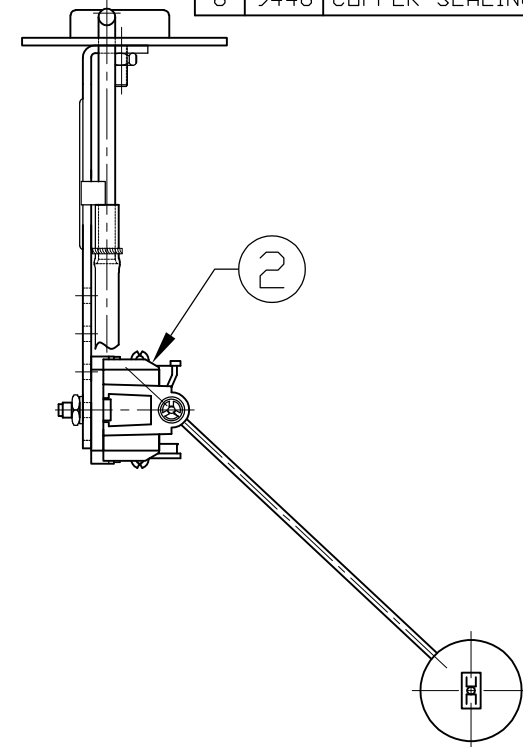
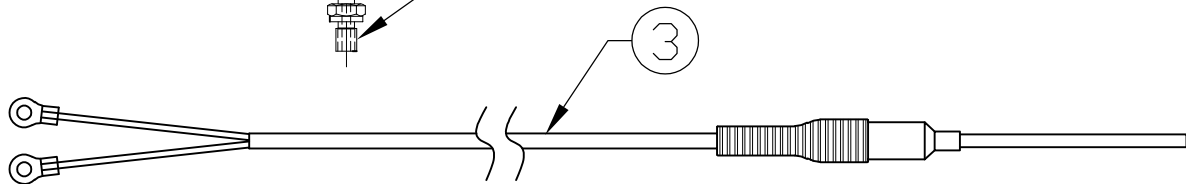

SIG. NO.	REVISION	DATE
 Neoteric Hovercraft Inc. 1649 TIPPECANOE STREET TERRE HAUTE, INDIANA, U.S.A. 47807-2394 TELEPHONE (812) 234-1120 FAX (812) 234-3217		
DRAWN: CJ POEHLEIN	NAME: HOVERTREK SENDERS	REV. 2
DATE: 9 JUN, 2015	NUMBER: 16647	