

EXPLODED VIEW

BILL OF MATERIAL		
REF.	PART #	DESCRIPTION
1	3728	END CAP
2	5825	UPPER STEERING COLOUMN BEARING, KIT
3	3925	HT STEERING COLUMN ASSY
4	3587	SHAFT COLLAR, AL
5	3731	STEERING COLUMN WASHER
6	3833	LOWER STEERING COLUMN BEARING, KIT
7	5829	CLEVIS ASSY, MODIFIED
8	3805	RUDDER CABLE STOP, REAR
9	3834	FORWARD CABLE MOUNT KIT
10	3804	RUDDER CABLE STOP, FORWARD
11	3644	HT4 RUDDER CABLE
11	5640	HT6 RUDDER CABLE
12	3492	GRIP, PORT
13	7369	REVERSE THRUST CONTROL LEVER
14	6539	MODIFIED HT HANDLEBAR CLAMP, BLACK
15	1920	HL HANDLEBAR
16	7364	PLASTIC SINGLE CABLE THROTTLE
17	6617	THROTTLE REPLACEMENT GRIP
18	7362	CONTROL LEVER STOP SCREW
19	7372	CABLE LENGTH ADJUSTER SCREW
20	7348	CHOKE LEVER & NIPPLE
21	7363	CABLE NIPPLE & ADJUSTMENT SCREW
22	7371	CONTROL LEVER CLAMP SCREW
23	7370	REVERSE THRUST CONTROL LEVER CLAMP
24	7454	CRUISE CONTROL

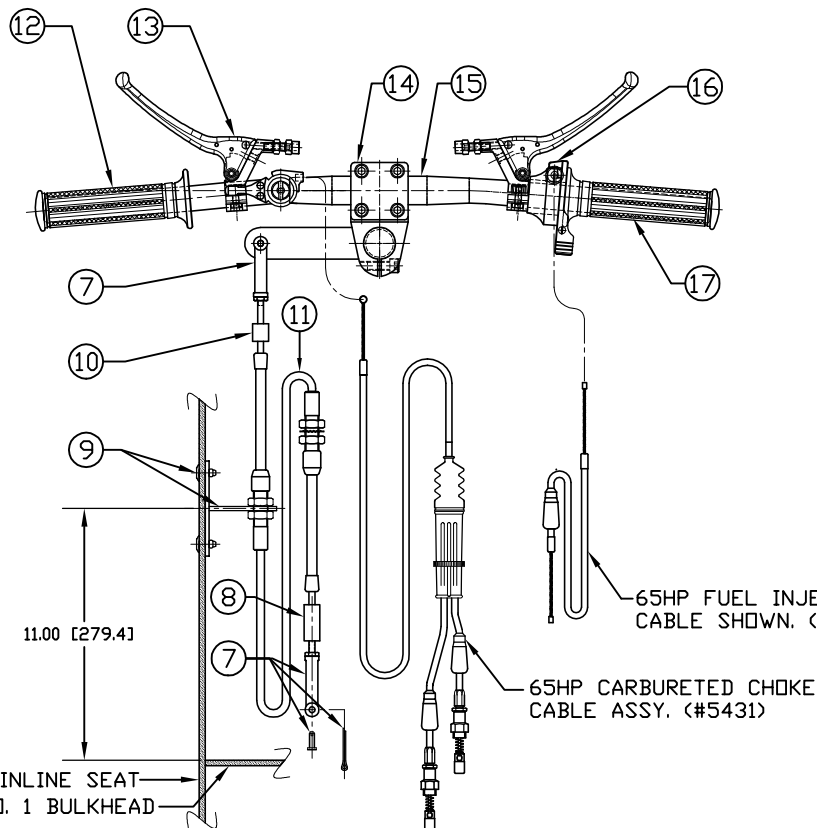

TOP VIEW

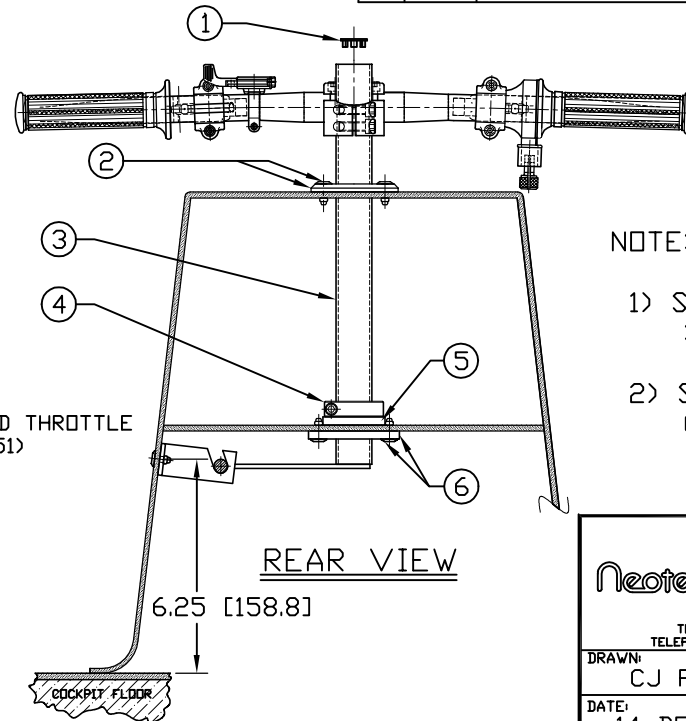

REAR VIEW

NOTES:

- 1) SHOWN WITH 309 SERIES CONTROLS.
- 2) SEE FORM # 17359 FOR CABLE PART NUMBERS.

Neoteric  Hovercraft Inc.

1649 TIPPECANOE STREET  
 TERRE HAUTE, INDIANA, U.S.A. 47907-2394  
 TELEPHONE (812) 234-1120 FAX (812) 234-3217

DRAWN: CJ POEHLIN	NAME: INLINE CONTROLS
DATE: 14 DEC, 2012	NUMBER: 17109 REV. 2